

GÜHRING

PRESSRELEASE

aus-tech 2019

Stand # 854

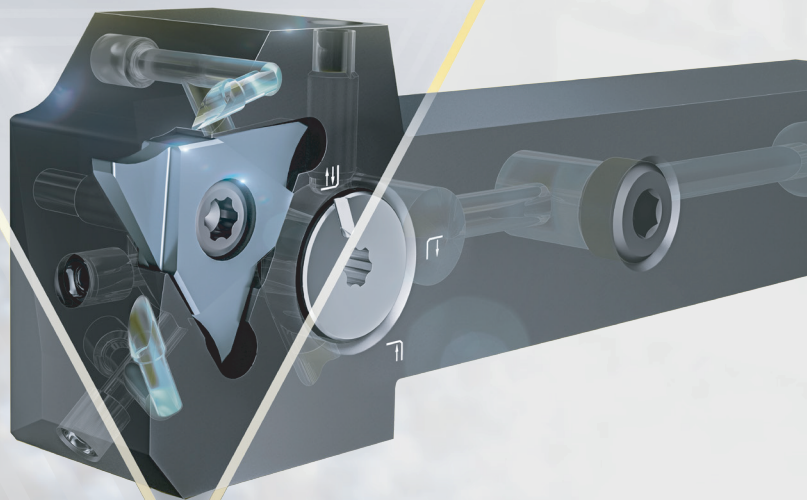
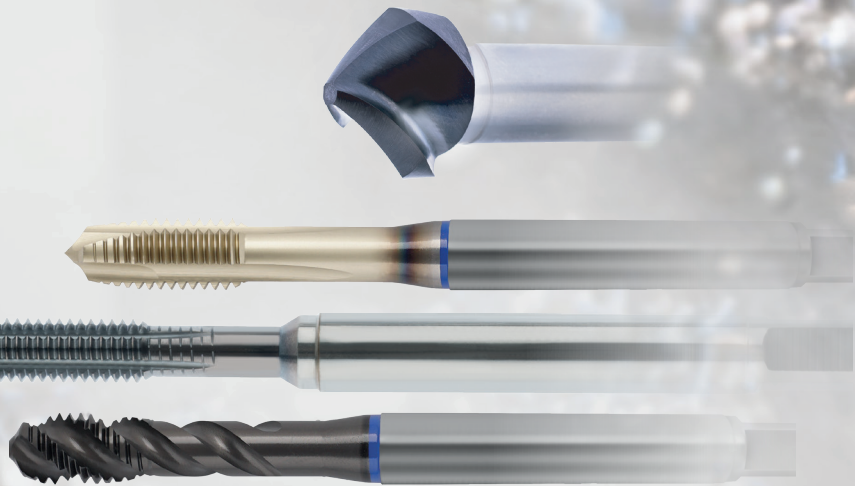

Guhring Australia

6 Jacks Road, Oakleigh South
VIC 3145

Contact

T: 1800 639 991

F: 03 9948 4699

E: sales@guhring.com.au

Visit www.guhring.com.au

CONTENTS

PRESSRELEASE

PRODUCTS & SERVICES

SpyroTec countersink

90° spiral countersink with convex cutting edges

Gühring as a complete supplier

A rapidly growing range of stationary tools for turning operations

SC Line Thread milling cutters

Fast thread milling with high-end performance

RT 100 Al ratio drill

Strong in aluminium

Gühring Trochoidal Cutting (GTC)

High-performance roughing with maximum cutting depth

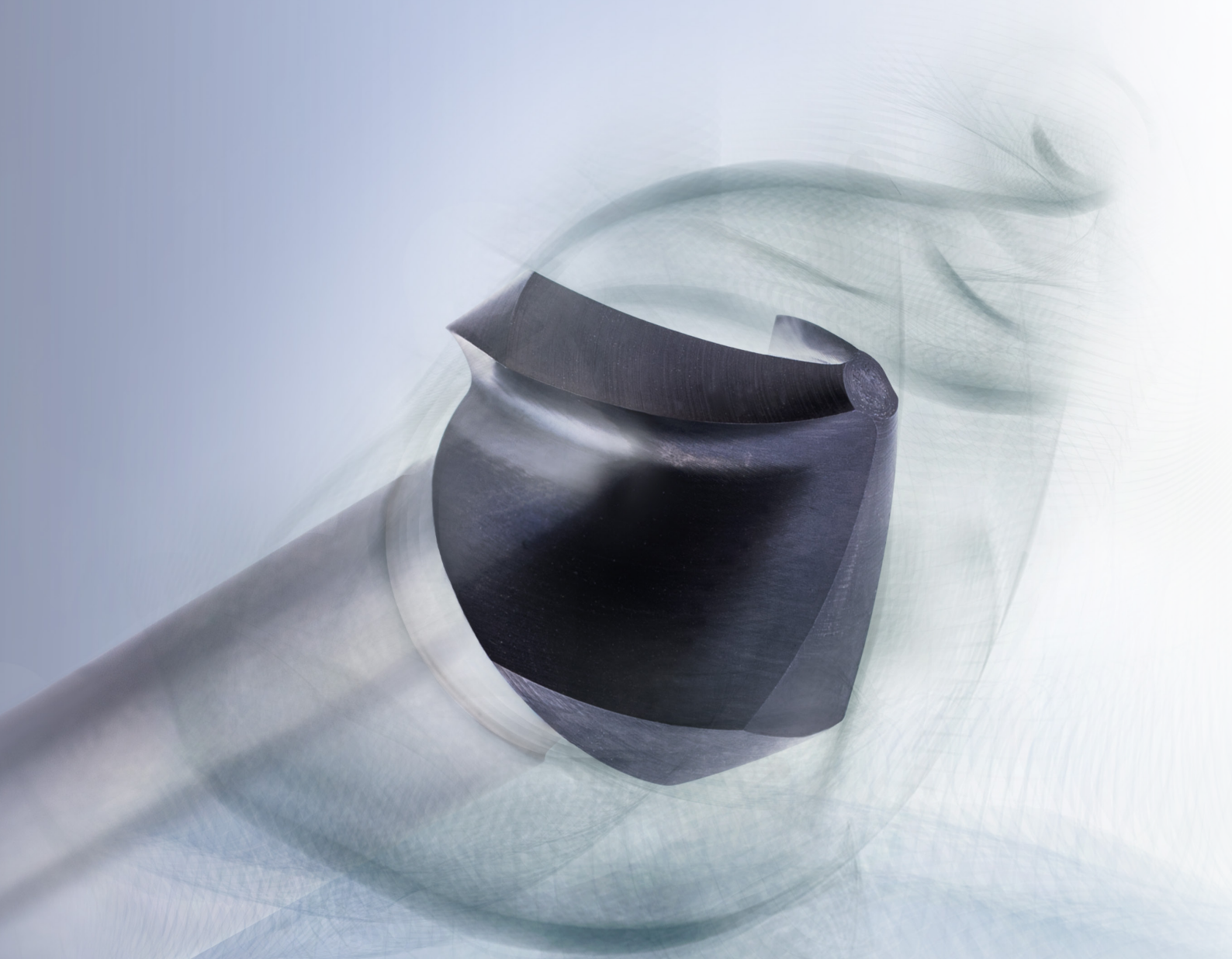

Countersinks SpyroTec

90° spiral countersinks with convex cutting edges

SpyroTec's newly developed cutting geometry significantly reduces the axial and radial forces generated during countersinking operations. Also with hand drills an easy and convenient countersinking is guaranteed. Due to convex different radii of the cutting edges with variable helical pitch provide a stable and low-vibration countersinking process. Round, precise and chatter-free countersinking is guaranteed.

The specially designed TiAlN coating ensures a higher wear resistance and high-temperature hardness which guarantee longer tool life of nearly all materials and applications.

Versatile designs for universal application

The SpyroTec countersink by Gühring is available from stock in all major designs: the complete range includes a version with a straight shank, a version with a 3-surface shank for feeding into 3-jaw chucks and an extra long version for bridging interfering contours. Gühring also offers sets containing the most popular sizes for the versions with the straight shank and 3-surface shank.

An overview of the benefits

- universal application on nearly all materials
- round, precise and vibration-free countersinking
- feed force reduced by 60 %
- radial force reduced by 50 %



Countersinking with standard countersink



Countersinking with SpyroTec

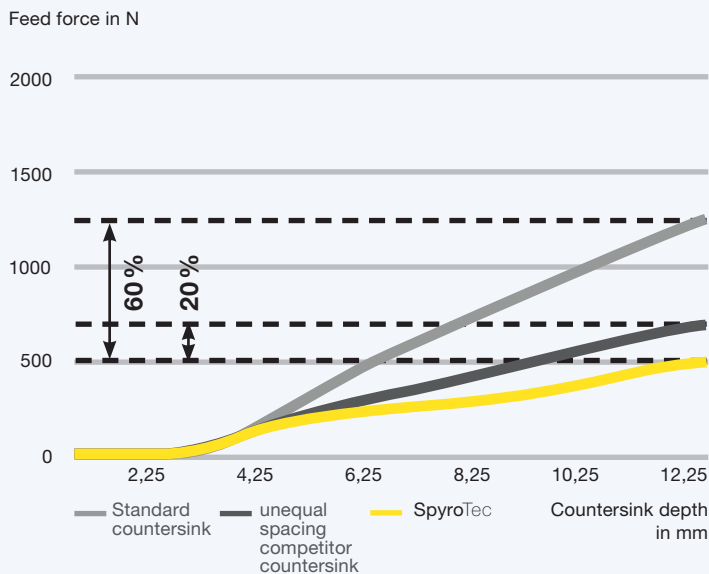

FEED FORCE REDUCED BY APPROX. 60 %
COMPARED TO THE STANDARD COUNTERSINK

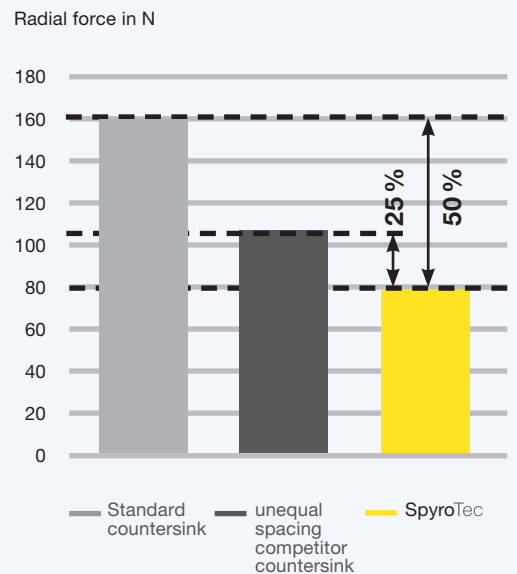

RADIAL FORCE REDUCED BY APPROX. 50 %
COMPARED TO THE STANDARD COUNTERSINK

Convex cutting edges

Three different convex cutting edges in combination with three unequal helix angles enable extremely stable and low-vibration cutting processes without any chatter marks.

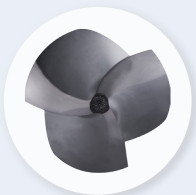

Cutting material

The 5 % cobalt-alloyed, high-speed steel makes the tool highly resistant to heat and tempering, giving it a long service life. The tool's cutting material allows it to be used for almost every material.

TiAlN coating

The titanium aluminium coating stands out for its high level of hardness and good thermal resistance.

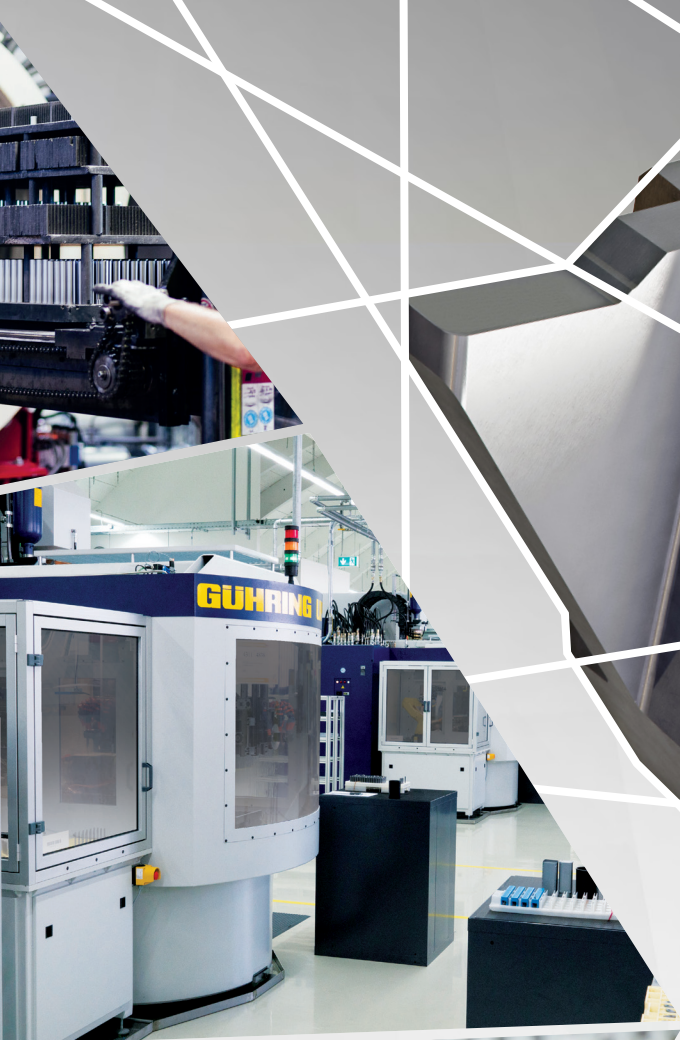

GÜHRING **GROOVING** **SYSTEMS**

GÜHRING AS A COMPLETE SUPPLIER

A RAPIDLY GROWING RANGE OF STATIONARY TOOLS FOR TURNING OPERATIONS

Gühring has been a specialist in rotating cutting tools for many years, having been a drill pioneer since 1898 and has also gradually expanded to include milling, reaming and threading tools. Since launching its grooving tools at AMB 2016, the tool manufacturer has been more aware of its reputation as a complete supplier than ever before. And it's still developing.

With the 104 and 106 systems for boring out, grooving, axial grooving, threading and broaching internal diameters, Gühring covers inside diameters from 0.7 mm to 6 mm. This makes it possible to machine materials in one setting, either in a normal position or overhead. Simply turn the insert over to set it to centre height. Another benefit is the variable cooling of the cutting edges during radial and axial machining. In the tried and tested 106 system, a larger selection of grooving tools is now available. These are now available for machining internal hexagons of spanner sizes 4 to 10.

CONTINUOUS PRODUCT RANGE EXPANSION

Just two years after the product range was launched, Gühring expanded its range of grooving tools, not only introducing more sizes but also two completely new systems. As early as EMO 2017, the 104 and 106 systems were accompanied by tool holders for automatic lathes as well as modular inputs. The range of cutting inserts has also been expanded in terms of diameter, radius and length.

108

STREAMLINED WITH GREAT STABILITY

The new 108 system is the logical development of the micro-precision tool range. With a shank diameter of 8 mm and a minimum machining diameter of 7 mm, the 108 system is a valuable addition to the existing tool portfolio.

The shank diameter of 8 mm provides maximum stability and therefore high processing safety. The basic range features over 700 different items for boring out and profiling up to t_{max} 2.5 mm, internal grooving up to t_{max} 3 mm and back boring.

At the time of programme launch, the selection of clamping holders comprises all conventional sizes and designs. Gühring is already planning to make numerous additions in line with user requirements.



110

AND MORE SPECIAL SOLUTIONS

System 110 also opens up new and exciting opportunities. With a shank diameter of 10 mm, these special tools ensure maximum stability. Gühring has blanks in stock with a length of up to 112 mm in order to provide the best possible solution for challenging applications.

We would be happy to investigate the design of even longer tools for you.

In addition, the standard programme includes most conventional round shank holders.

Gühring specialises in industry-specific tool and process solutions. The tool manufacturer is also able to design custom-made special tools for grooving operations. As well as our comprehensive standard portfolio, we particularly aim our strong customer focus at tailored systems. This is based in particular on Gühring's substantial tool expertise and extensive consulting experience.



GÜHRING'S IN-HOUSE PRODUCTION RANGE IS SECOND TO NONE

The rapid development in turning, amongst other things, is made possible by Gühring's huge depth of production, which is also evident in the new turning tool product line. Carbides manufactured in-house, specially developed machines and coatings from our own R&D are typical of Gühring products. This is no longer exclusive to rotating tools, as it now also applies to stationary tools.

FAST
THREAD MILLING
WITH HIGH-END PERFORMANCE

THE SC LINE THREAD MILLING CUTTER

In terms of processing safety and threading quality, thread milling is still the most common procedure for cutting threads. The newly designed SC Line of thread milling cutters now machines even faster, consisting of micro thread milling and thread milling cutters with 45° chamfers, each with up to eight cutting edges.

The SC-MTM3 SP micro thread milling cutter, for example, significantly extends the service life, even for small diameters and materials of up to 1,300N/mm². The SC-TMC SP threading tool with a chamfer is characterised by its combination of countersink and thread milling cutter. Customers will be impressed by this smooth-running tool with reduced lateral forces. Thanks to their additional cutting edges, both thread milling cutters operate significantly faster and score with their increased tool life. The combination of new carbide, perfectly coordinated coating and new tool geometry means that threads can be manufactured true to gauge for longer. Radius compensation is not necessary for machining with SC tools until significantly later.

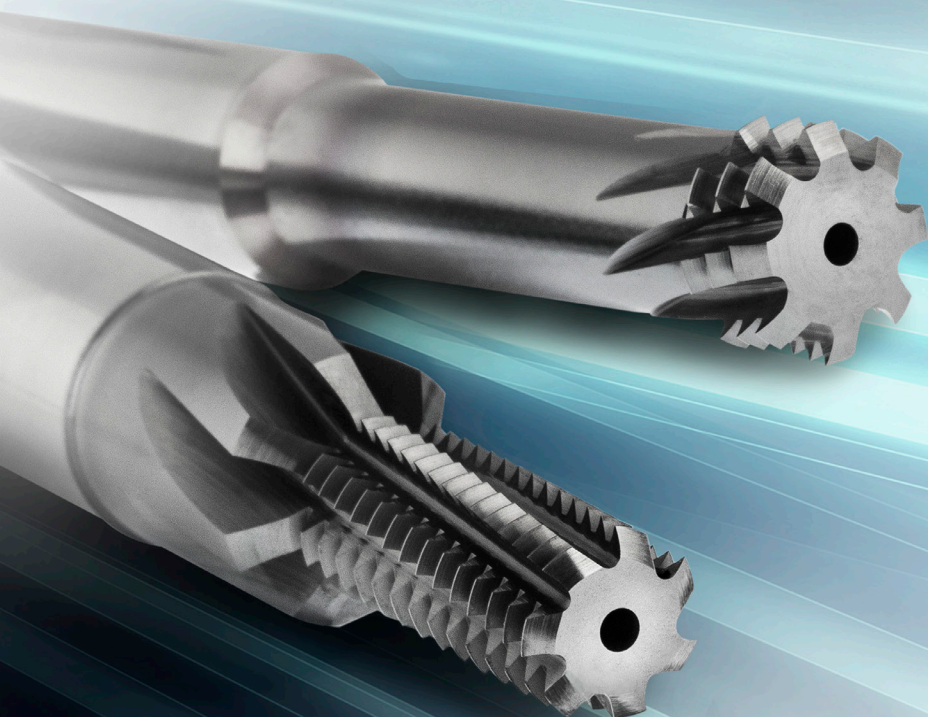

SC-MTM3 SP: Micro thread milling cutter

Increased number of cutting edges

With up to eight cutting edges, the SC-MTM3 SP can cut materials significantly faster. Machining time is reduced by up to 50% – for micro machining too.

Left-hand cutting geometry

The new left-hand cutting geometry increases tool life by up to 100%, especially for synchronisation procedures.

Increased resistance to wear

The combination of new carbide, TiCN coating and new tool geometry means that threads can be manufactured true to gauge for longer. Radius compensation is not necessary until significantly later.

SC-LINE

SC-TMC SP: Thread milling cutter with 45° chamfer

New geometry

The new geometry allows the tool to stabilise while machining. It increases processing safety and extends the service life by up to 100% for synchronisation procedures. The Gühring tool with left-hand cutting geometry can in particular achieve a longer service life, especially for synchronisation procedures. The material is cut with stable residues.

Increased number of cutting edges

With up to eight cutting edges and optimised geometry, the SC-TMC SP can nearly halve machining time.

Increased resistance to wear

The combination of new carbide, AlCrN coating and new tool geometry means that threads can be manufactured true to gauge for longer. Radius compensation is not necessary until significantly later.

An overview of the SC Line:

- top thread milling performance
- up to 1,300N/mm²
- machining time reduced by up to 50%
- service life extended by up to 100%
- reliable machining and even increased processing safety

N

Strong in aluminium

RT 100 AL RATIO DRILL

Chip removal, as well as chip formation, is crucial for machining non-ferrous metals. The RT 100 AI achieves optimum chip formation on the cutting edge across the full range of materials – from soft, elastic non-ferrous alloys to brittle cast aluminium or brass alloys. Chips are reliably removed.

The RT 100 AI is characterised by its open point geometry, with high surface finish qualities in the web thinning, front face and clearance rake areas. The micro-treated cutting edges and cutting corners complete the tip geometry and ensure a perfect cutting performance. Low processing temperatures prevent the formation of built-up edges when machining non-ferrous metals.

This is mainly due to the sharp, micro-treated cutting edges, which ensure the perfect cut even when machining heat-treated AISi alloys. The open point geometry and concave cutting edge shape guarantee optimum chip formation. The polished groove profile on the RT 100 AI ratio drill minimises friction and reliably removes chips. Even material adhesion does not cause any problems.

The tool design is based on the specific requirements for machining aluminium. This is how the carbide grade is specially adapted for the machining of non-ferrous metals. This individual design of cutting material is only possible because Gühring produces its own carbide. The tools are bare metal and come with an HA shank in accordance with DIN 6535. Special sizes, stepped and MMS tools are available on request. Drill depths of up to 5xD are available as a standard size.



Gühring Trochoidal Cutting (GTC)

High-performance roughing with maximum cutting depth



Trochoidal milling is making a comeback. This milling strategy involves the tool moving in an elliptical motion, during which the circular tracks overlap each other. The milling procedure is not completely new. But it is only on the basis of the performance of today's machining centres and geometrical adjustments, as well as the tools' increased resistance to wear, that GTC is emerging as a further development in machining and is often used when very high material removal rates are required.

GTC (Gühring Trochoidal Cutting), a milling procedure with a circular feed motion, prevents the frequent, sudden strain placed on the tool during conventional milling. Controlling the cutter path with low radial depth allows the tool to be inserted into or pulled out from the work piece comparatively smoothly. Trochoidal roughing is ideal for machining deep cavities, as the roughing cutter machines the entire depth of the contour with the whole length of the cutting edge. Low cutting forces and the even distribution of them across the entire length of the cutting edge enables high machining speeds and long service lives.

Gühring now offers a special range of GTC tools specifically intended for this milling strategy:

RF 100 Speed – two new designs

- // RF 100 Speed P with an effective cutting angle of 3° for steel, high-strength steel and cast iron
- // RF 100 Speed M with an effective cutting angle of 9° for soft-elastic materials and stainless steel, as well as special alloys, titanium and nickel

RF 100 iMill

- // for machining softer and more elastic materials

RF 100 Ti

- // for high-performance machining of high-strength special materials that are difficult to cut, such as titanium or nickel alloys

RF 100 Raptor

- // for machining steel, titanium and stainless materials

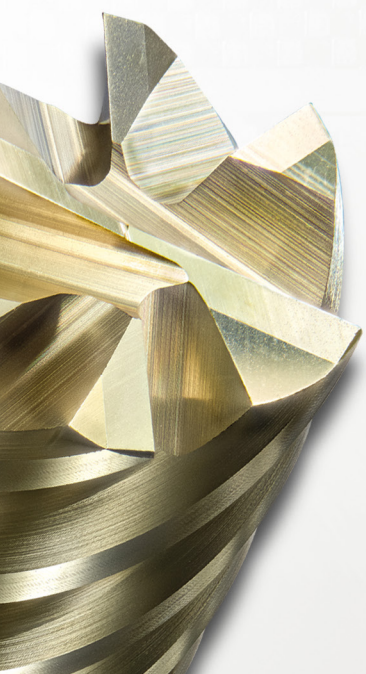

AN OVERVIEW OF THE BENEFITS

- // high-performance roughing, even at high cutting depths
- // runs very smoothly with a high material removal rate
- // GTC milling on a huge variety of steel and cast iron grades as well as special alloys

TOOLS FOR GTC MACHINING

- // premium material removal rate with maximum processing safety
- // have a high machining depth and use the entire length of the cutting edge
- // geometry and coating are adapted to the maximum machining parameters



Press release for download
including printable photo material

<https://www.guhring.com.au/downloads/downloads.html>